

TrafficPatternsXD™
A TrafficScapes™ Solution by Ennis-Flint

DESIGN MANUAL



For sales & support in Canada contact HUBSS.com

HUB East (416) 540-9287

HUB West (604) 309-8212

DESIGN MANUAL

There are literally hundreds of design combinations for TrafficPatternsXD crosswalks and traffic calming surfaces. The purpose of this Design Manual is to provide a visual glance of ideas and suggestions using various combinations of patterns, borders, and colors.

Specifications and CAD drawings are available at www.hubss.com and www.CADdetails.com



Made of durable preformed thermoplastic pavement marking material, TrafficPatternsXD provides a cost-effective alternative to the use of brick and stone pavers and is virtually maintenance free. The pattern and color combinations allow designers the flexibility to create the ideal crosswalk or traffic calming pattern that complements an overall streetscape design.

Ennis-Flint, the world's leading manufacturer and distributor of preformed thermoplastic pavement marking materials, makes a complete line of products at our U.S. facility which is ISO 9001:2008 certified for design, development, and manufacturing. Ennis-Flint offers pavement markings for use on streets and highways, crosswalks, intersections, parking areas, and many airside and landside uses at airports. From lines, legends, and arrows to traffic calming crosswalks and detectable warnings, Flint's products help motorists, cyclists, pilots, and pedestrians move in the right direction...safely.

4786 217a St. Langley BC Canada

(604) 309-8212

www.hubss.com

APPLICATION OVERVIEW

Applications are performed by Certified Applicators only. The 2 ft. x 2 ft. sheets of material are positioned on the non-stamped, prepared asphalt surface. The material is heated to allow proper embedment of the anti-skid elements. A specialized grid gently stamps a pattern into the material and just into the top layer of the asphalt.

1. APPLY SEALER & POSITION



2. HEAT MATERIAL



3. STAMP WITH WIRE GRID



TrafficPatternsXD Photos



Offset Brick



Ashlar Slate



Diagonal Herringbone



Diagonal Herringbone



Square Tile



Square Tile

POPULAR BORDERS & PATTERNS

Drawings below represent the wire grids that are stamped into the asphalt surface to create specified pattern.



BORDERS

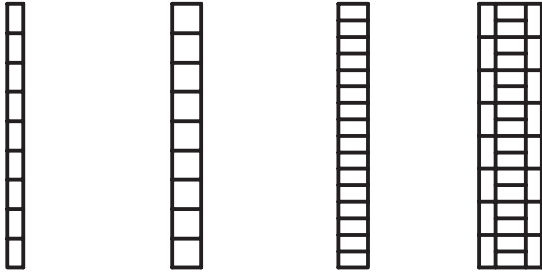

PATTERNS

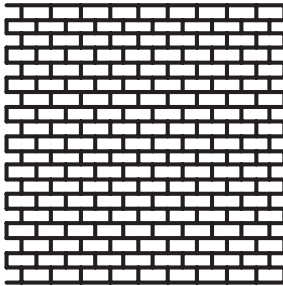

Offset Brick
Brick Size: 4-3/4" x 9-5/8"
(12.4cm x 24.3cm)

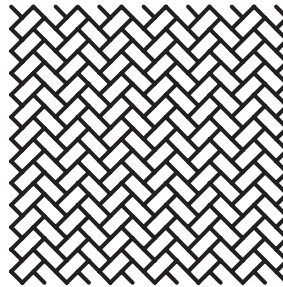

Diagonal Herringbone
Brick Size: 4-7/8" x 9-3/4"
(12.3cm x 24.7cm)

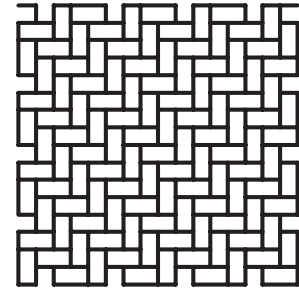

Standard Herringbone
Brick Size: 4-7/8" x 9-3/4"
(12.3cm x 24.7cm)

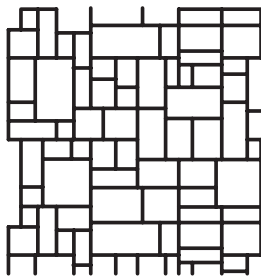

Slate
Brick Size: 3" to 16"
(7.6cm to 40.56cm)

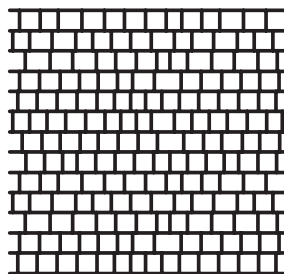

Cobble
Brick Size: 4-7/8" x varies
(12.3cm x varies)

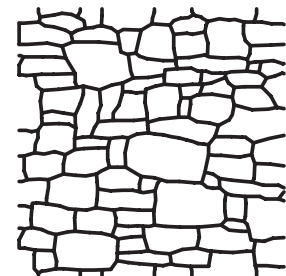

Stone
Brick Size: varies 4" to 1'-4"
(varies 10cm to 40cm)

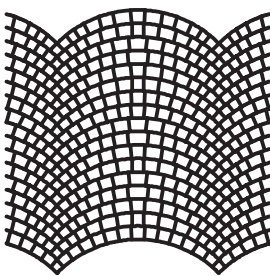

Eurofan
Brick Sizes: 3" to 4" x varies
(7.6cm to 10.1cm x varies)

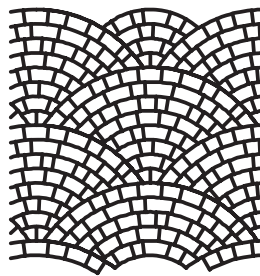

Scallop
Brick Size: 4-1/2" x varies
(11.4cm x varies)

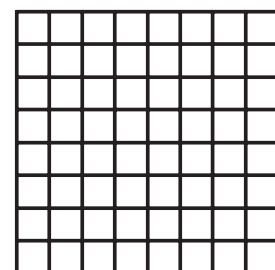

Tile
Brick Size: 4", 8", 10" and 12"
(10.1, 20.3, 25.4, and 30.4cm)

OFFSET BRICK

Wire-Rope Grid		
XDG-10-100	8'W x 14'L	Offset Brick
XDG-10-101	14'W x 8'L	Offset Brick
XDG-10-102	8'W x 14'L	Open Offset Brick with Stacked Brick Border
XDG-10-103	8'W x 14'L	Closed Offset Brick Stacked Brick Borders
XDG-10-104	6'W x 10'L	Offset Brick
XDG-10-105	11'W x 6'L	Offset Brick
XDG-10-106	6'W x 10'L	Open Offset Brick with Stacked Brick Border
XDG-10-110	1'7" W x 12' L	Offset Brick Edger
XDG-10-111	8'W x 2'9"L	Offset Brick

Drawings below represent the wire grids that are stamped into the asphalt surface to create specified pattern.

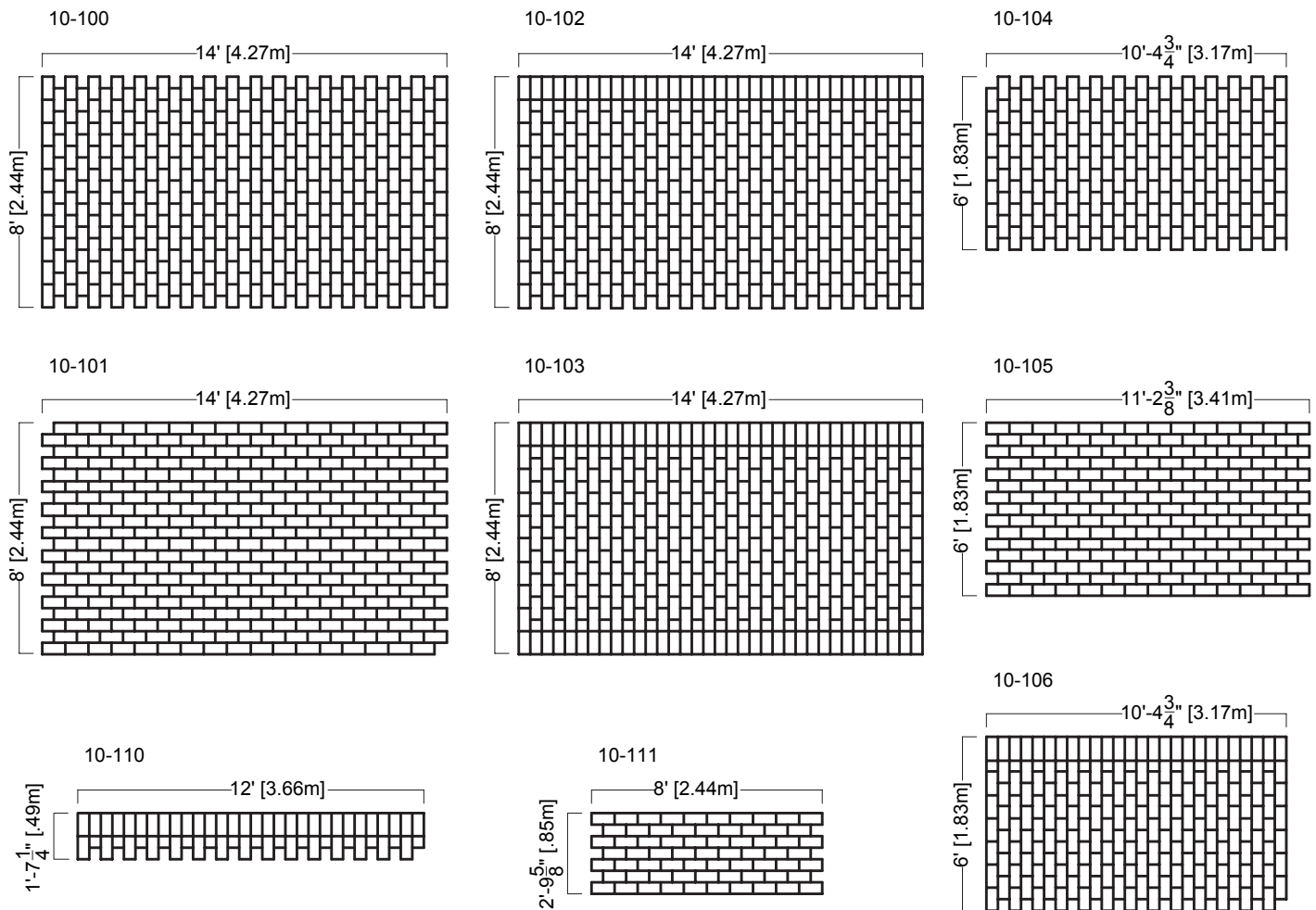

SEE PAGE 12 FOR SUPPORTING BORDERS: 10-110, 18-100, 18-106

HERRINGBONE

Wire-Rope Grid		
XDG-12-101	8'L x 14'W	Diagonal Herringbone
XDG-12-102	8'W x 14'L	Open Diagonal Herringbone with Tile Border
XDG-12-103	8'W x 14'L	Closed Diagonal Herringbone with Tile Borders
XDG-12-104	6'L x 11'W	Diagonal Herringbone
XDG-12-105	6'W x 11'L	Open Diagonal Herringbone with Tile Border
XDG-12-110	2'W x 12'10"L	Diagonal Herringbone Edger
XDG-12-111	3'1"W x 7'8"L	Open Diagonal Herringbone
XDG-11-120-120	13'W x 9'9"L	Standard Herringbone for SR120
XDG-11-1-120	13'W x 6'L	Standard Herringbone
XDG-11-1-219	10'W x 6'L	Standard Herringbone
XDG-11-1-121	5'W x 8'L	Standard Herringbone

Drawings below represent the wire grids that are stamped into the asphalt surface to create specified pattern.

DIAGONAL HERRINGBONE

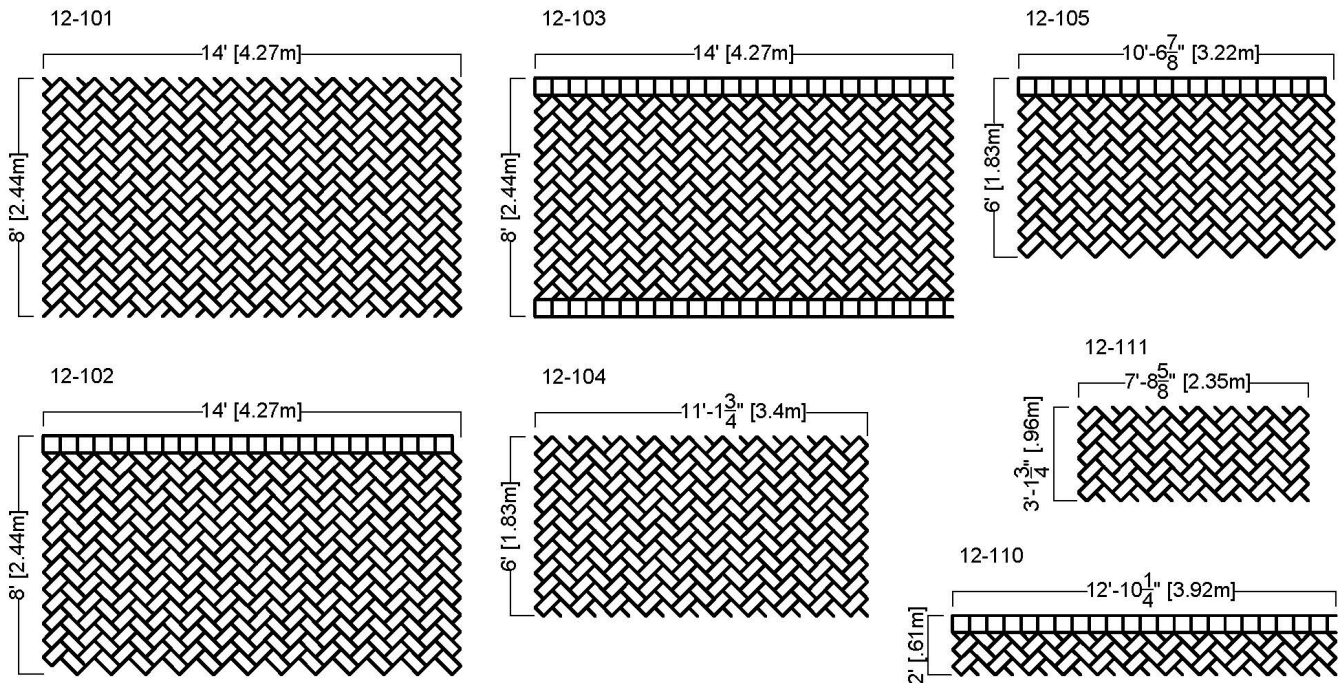

STANDARD HERRINGBONE

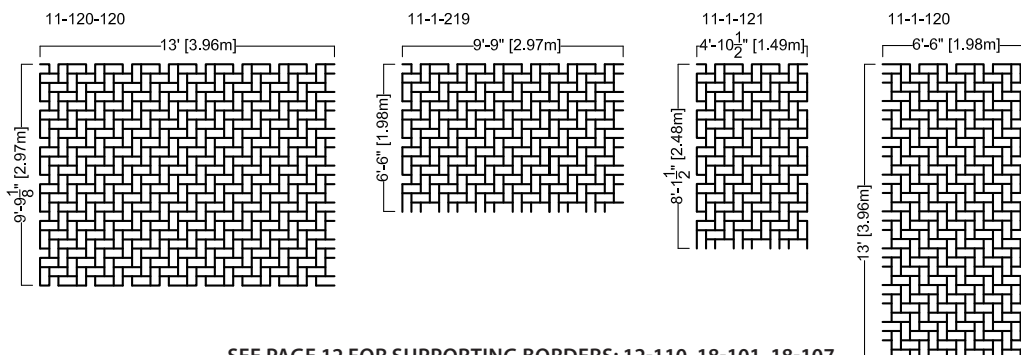

SEE PAGE 12 FOR SUPPORTING BORDERS: 12-110, 18-101, 18-107

SLATE

Wire-Rope Grid		
XDG-13-120-146	12'9" x 9'9"	Ashlar Slate for SR120
XDG-13-61-399	6'11" x 9'9"	Ashlar Slate Half size of SR120, works with SR60
XDG-13-111	8' x 2'10"	Mini Accent

Wire-Rope Grid		
XDG-28-120-374	12' x 9'	Random Slate SR-120
XDG-28-1-374	12' x 6'	Random Slate
XDG-28-1-375	9' x 6'	Random Slate
XDG-28-1-376	6' x 6'	Random Slate

Drawings below represent the wire grids that are stamped into the asphalt surface to create specified pattern.

ASHLAR SLATE

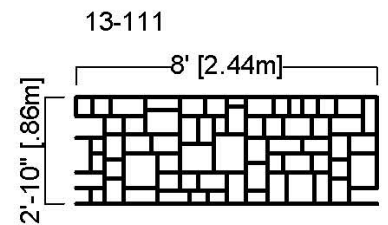
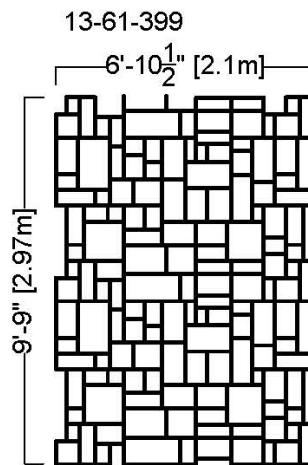
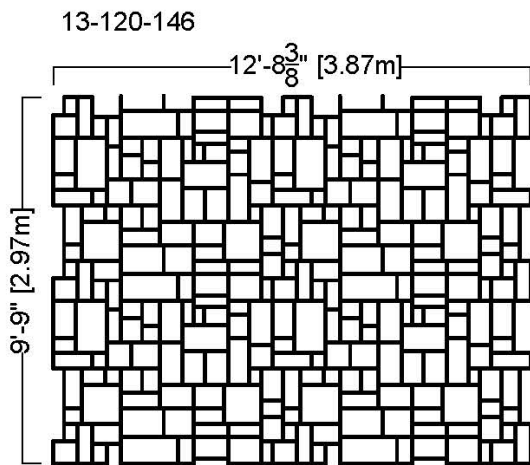

RANDOM SLATE

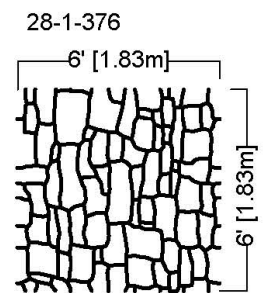
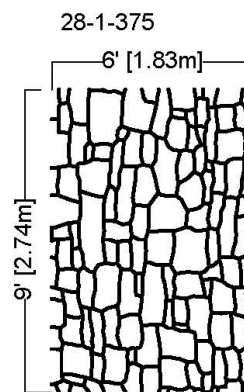
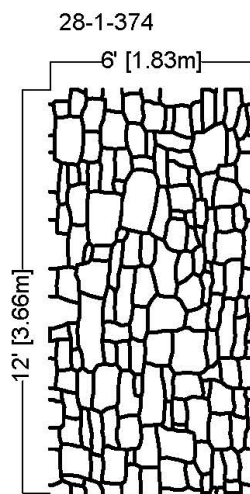
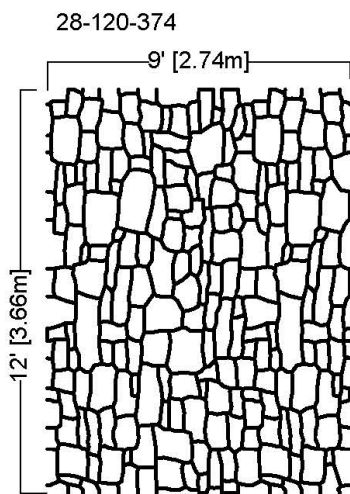

COBBLE

Wire-Rope Grid		
XDG-14-120-149	13'W x 9'9"L	British Cobble
XDG-14-1-149	13'W x 6'L	British Cobble
XDG-14-1-150	6'W x 9'L	British Cobble
XDG-14-61-387	10'W X 6'L	British Cobble

Wire-Rope Grid		
XDG-24-3-319	13'W x 6'6"L	Large Random Cobble
XDG-24-3-320	4'4"W x 6'6"L	Small Random Cobble
XDG-24-3-321	3'3"W x 4'4"L	Random Cobble Type A
XDG-24-3-322	3'3"W x 4'4"L	Random Cobble Type B

Drawings below represent the wire grids that are stamped into the asphalt surface to create specified pattern.

BRITISH COBBLE

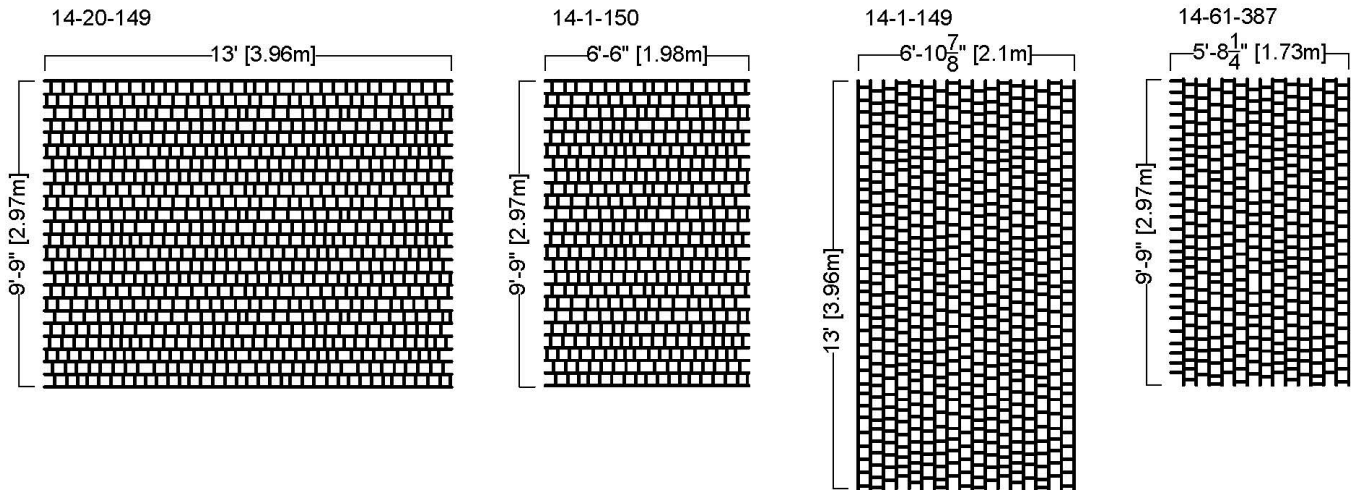

RANDOM COBBLE

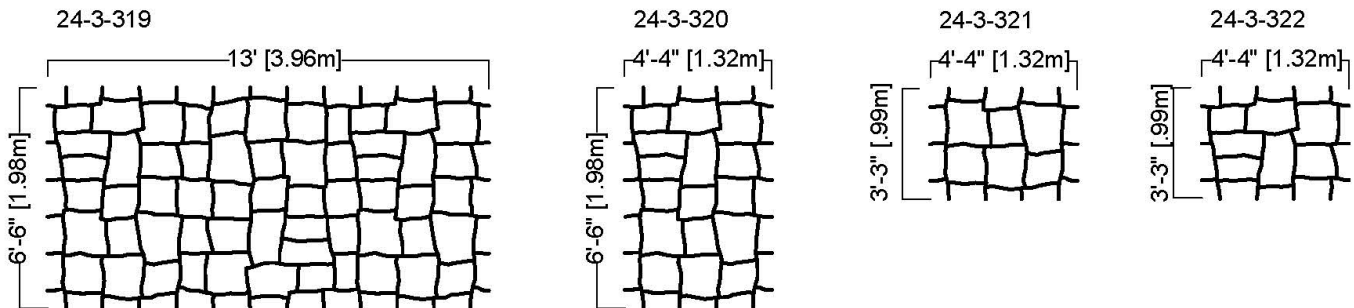

Brick Size: varies 8" to 2' (varies 20cm to 60cm)

STONE

Wire-Rope Grid		
XDG-28-1-378	18'W x 10'L	Thompson Stone - set of 3

Wire-Rope Grid		
XDG-21-1-252	10'8"W x 5'4"L	Random Stone
XDG-21-1-253	5'4"W x 5'4"L	Random Stone

Drawings below represent the wire grids that are stamped into the asphalt surface to create specified pattern.

THOMPSON STONE

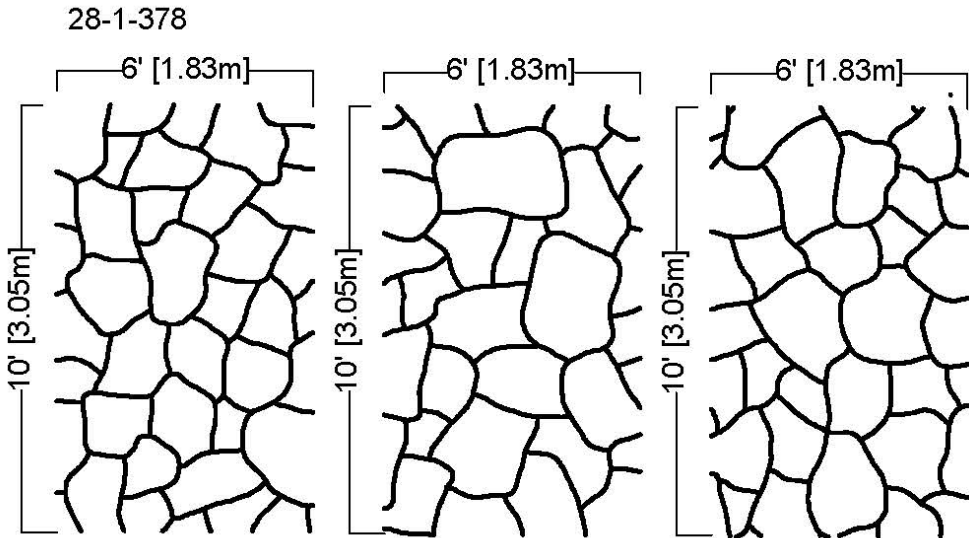

Brick Size: varies 1' to 3' (varies 30cm to 90cm)

RANDOM STONE

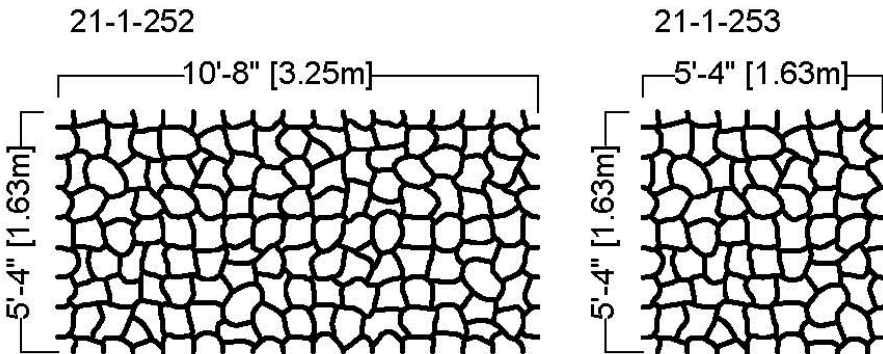

Brick Size: varies 8" to 12" (varies 20cm to 30cm)

EUROFAN

Wire-Rope Grid		
XDG-16-1-156	8' W x 4' 10" L	Eurofan
XDG-16-1-297	8' W x 5' L	Eurofan w/ open bottom
XDG-16-1-158	8' W	Eurofan Top
XDG-16-1-159	8' W	Eurofan Bottom

Drawings below represent the wire grids that are stamped into the asphalt surface to create specified pattern.

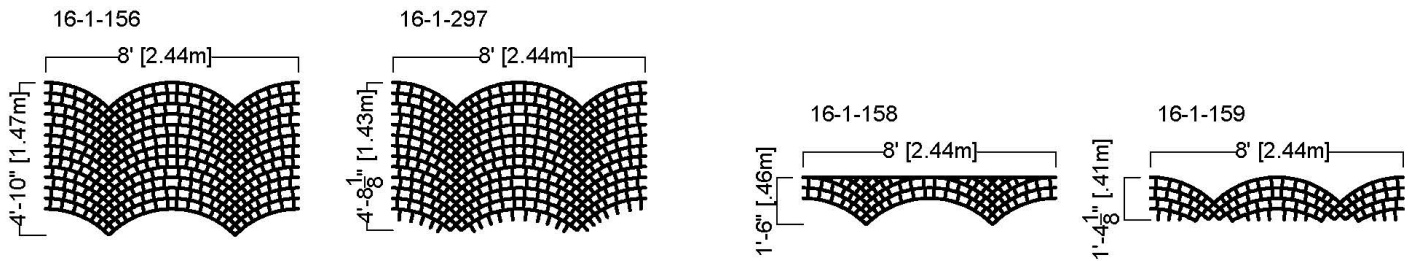

SCALLOP

XDG-21-1-370	12' 8" W x 6' 8" L	Scallop
XDG-21-1-377	6' 8" W x 6' 8" L	Scallop
XDG-21-1-372	12' W x 1' 6" L	Scallop Top Piece
XDG-21-1-373	12' 8" W X 1' 6" L	Scallop Bottom Piece

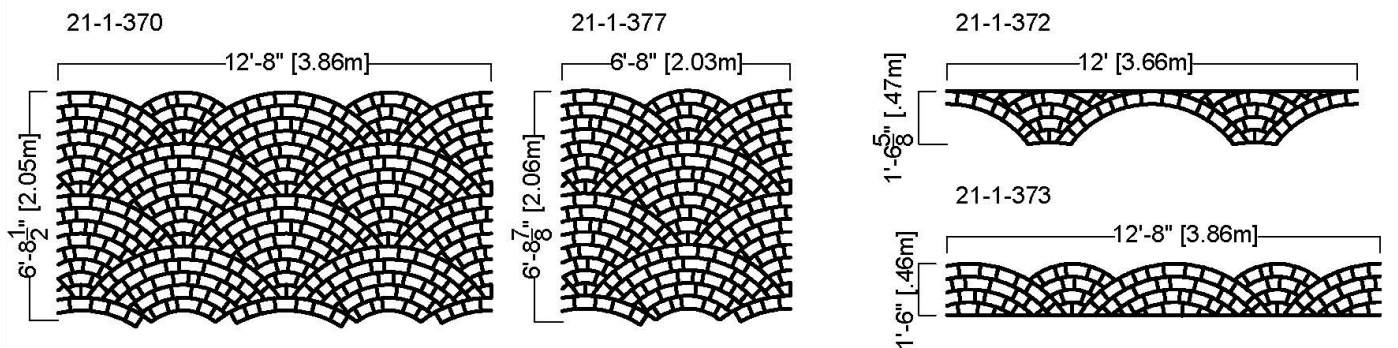

TILE

Wire-Rope Grid		
XDG-20-61-258	9'W x 7'L	4" Square Tile
XDG-20-61-259	9'W x 6.5'L	5" Square Tile
XDG-20-101	6'W x 10'L	6" Square Tile
XDG-20-102	7'6"W x 14'L	6" Square Tile
XDG-20-61-261	9.5'W x 6.5'L	8" Square Tile
XDG-20-61-262	9'W x 6.5'L	10" Square Tile
XDG-20-61-263	9'W x 7'L	12" Square Tile
XDG-30-61-385	8'10" x 5'10"L	5" Diagonal Tile

Drawings below represent the wire grids that are stamped into the asphalt surface to create specified pattern.

20-61-258

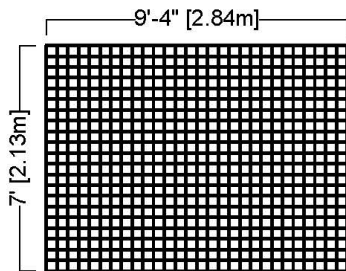

20-101

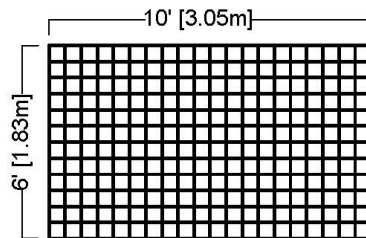

20-61-262

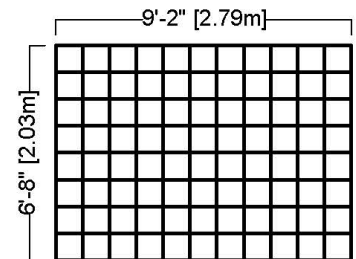

20-61-259

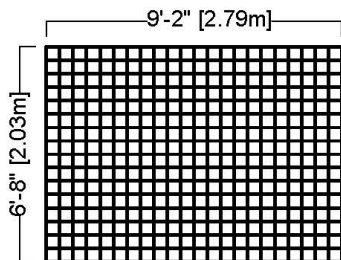

20-102

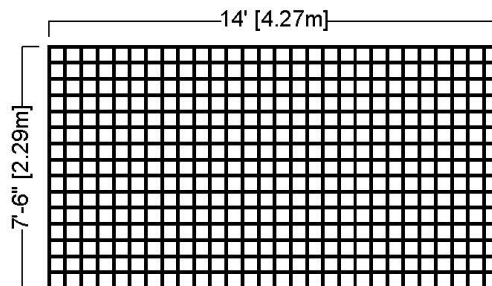

20-61-263

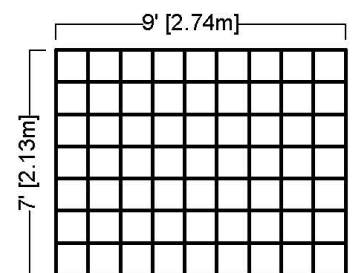

30-61-385

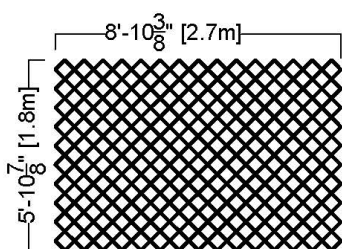

20-61-261

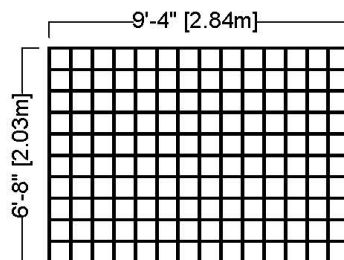

OFFSET TILE

Wire-Rope Grid		
XDG-20-61-500	9'4"W x 6'8"L	8" Offset Tile
XDG-20-61-501	9'4"W x 6'8"L	8" Offset Tile
XDG-20-61-502	9'2"W x 6'8"L	10" Offset Tile
XDG-20-61-503	9'2"W x 6'8"L	10" Offset Tile
XDG-20-61-504	9' x 7'	12" Offset Tile
XDG-20-61-505	7' x 9'	12" Offset Tile

Drawings below represent the wire grids that are stamped into the asphalt surface to create specified pattern.

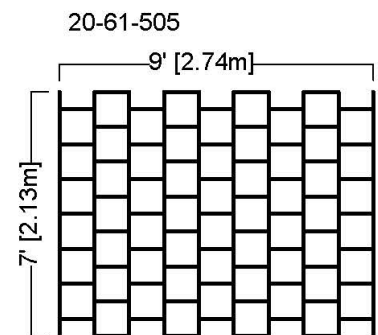
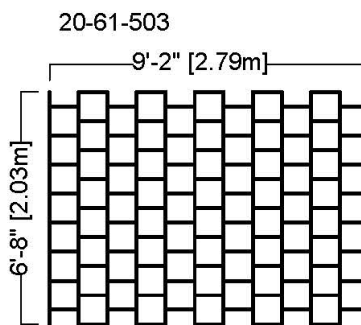
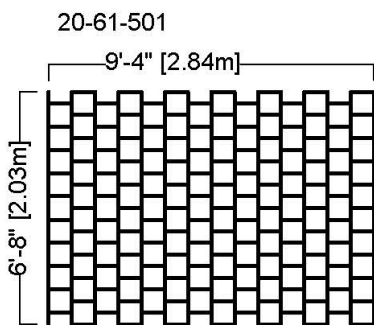
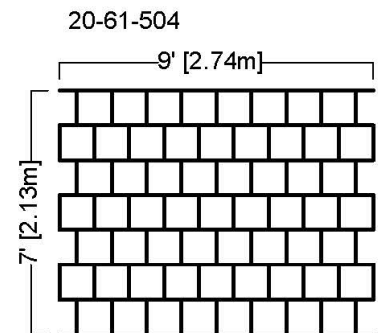
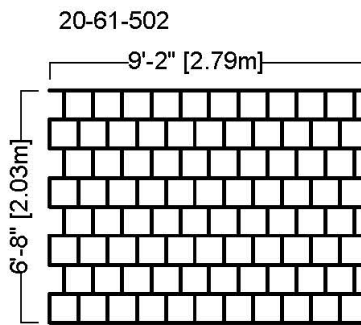
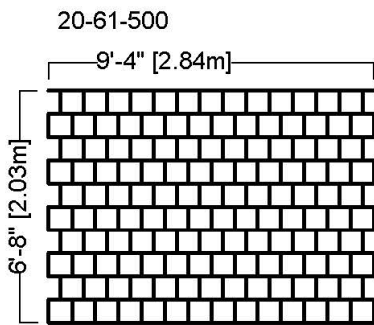

BORDERS

Wire-Rope Grid		
XDG-18-100	12'W x 10'L	Stacked Brick Border
XDG-18-101	12'W x 7"L	Tile Border
XDG-18-1-203	12'2"W x 5"L	Cobble Border
XDG-18-1-205	12'W x 9"L	Texas Cobble Border
XDG-18-1-207	11'10"W x 5L	End-to-End Border
XDG-18-1-199	12'2"W x 1'7"L	Soldier Course Straight

Wire-Rope Grid		
XDG-18-106	11'7"W x 10'L	Stacked Brick Flex
XDG-18-107	12'W x 7"L	Tile Border Flex
XDG-18-1-204	11'10"W x 5"L	Cobble Border Flex
XDG-18-1-206	11'1"W x 9"L	Texas Cobble Border Flex
XDG-18-1-208	11'1"W x 5"L	End-to-End Border Flexible
XDG-18-1-336	11'9"W x 1'6"L	Double Texas Cobble Border

Drawings below represent the wire grids that are stamped into the asphalt surface to create specified pattern.

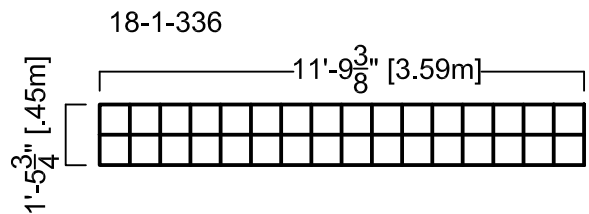
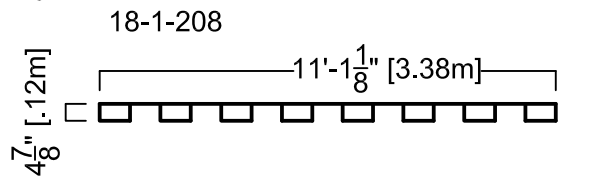
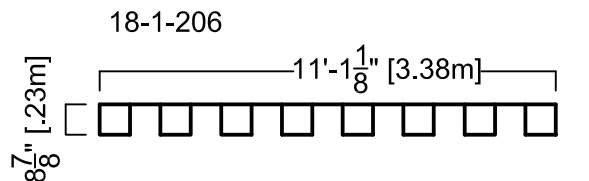
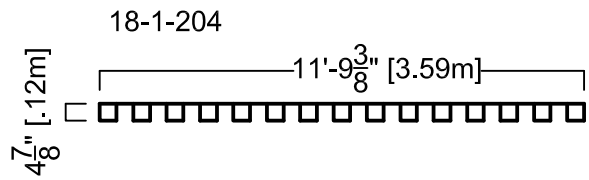
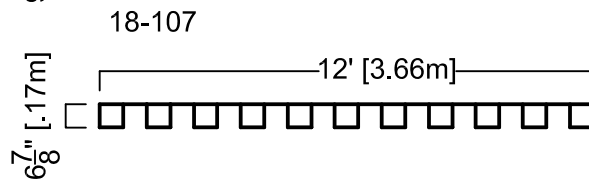
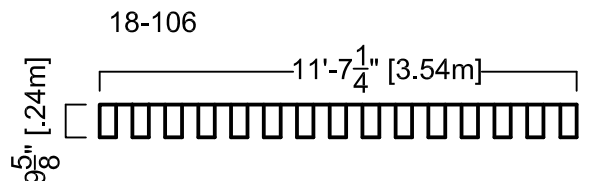
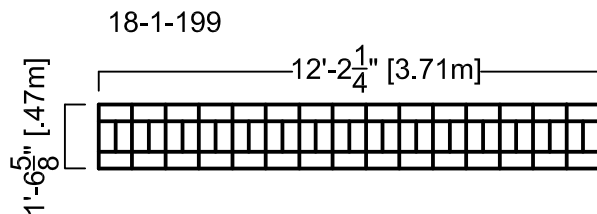
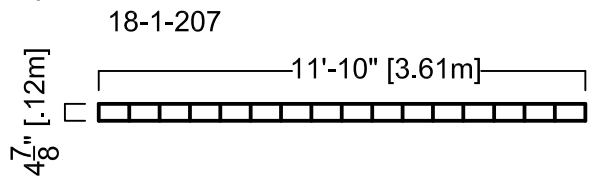
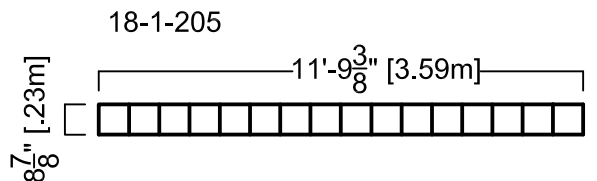
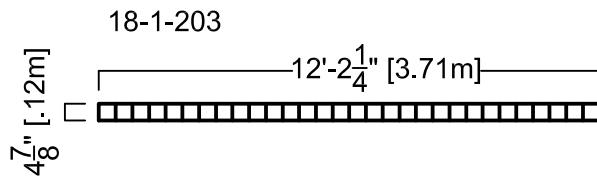
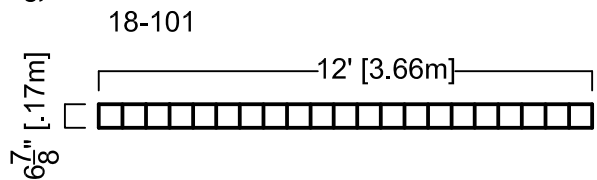
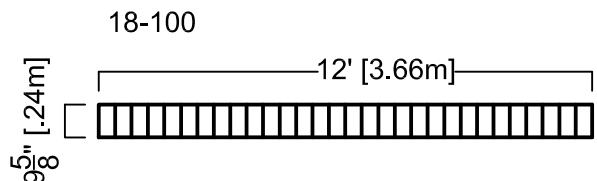

STANDARD COLORS



BLACK

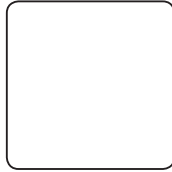

WHITE



SAND



TAN



BRICK RED



COLONIAL
BRICK



HERITAGE
RED



FIELD
GRAY

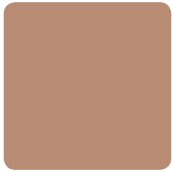

SONOMA
SAND



CINNAMON



SANTA FE
CLAY



CHESTNUT



GREY



DARK
BRICK RED



KHAKI



SIENNA



COCOA



SALMON